



# Future of Work: Thriving in the Hybrid Workplace with End-User Persona Solutions

**Mark Prosser**

Client Solutions Sales Specialist

Dell Technologies



As the future of work evolves  
How & where we work has changed

People are the center of it



# Accelerators of Change

Increase in  
**Hybrid Work**

---

Integration of  
**Emerging Tech**

---

Emphasis on  
**Employee Experience**

# Hybrid Workspaces

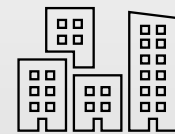
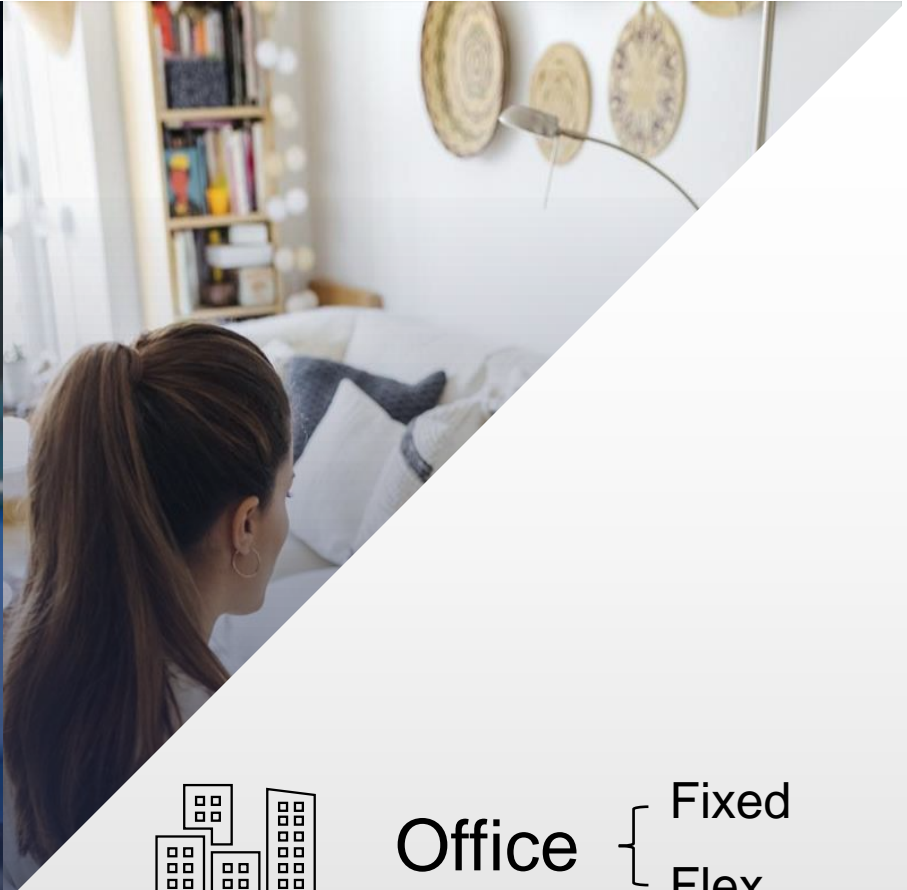

Office { Fixed  
Flex



Roam

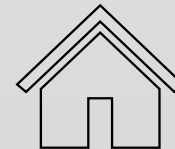

Home

# Delivering Hybrid Work Solutions

Centered around  
**Needs & Pain points**

Integration of  
**Emerging Tech**

Emphasis on  
**Employee Experience**

# Commercial End User Personas

(Pre-2022)  
Based on:  
"Where"  
We Work



On-The-Go-Pro



Corridor Warrior



Desk Centric Worker



Remote Worker



Based On:  
"What"  
We Do



**BUILDER**



**CONNECTOR**



**SPECIALIST**



**PRODUCER**



# Commercial End User Personas



10% of  
workforce

## Builder

Driven to build and grow the business. Creates and executes strategic **vision**. Moves companies forward developing **relationships** with **external** stakeholders and partners.



19% of  
workforce

## Connector

Driven to **connect** teams and ensure **collaboration**. Manages plans and data to advance projects. Enables **progress** by balancing between collaboration and distractions.



15% of  
workforce

## Specialist

Driven to specialize in unique, **creative**, and **complex** fields. Generates focused work and performs detailed **analysis**. Solves difficult challenges in a logical and detail-oriented manner.



>50% of  
workforce

## Producer

Driven to produce results and strives for **efficiency**. Focuses on **productivity** to deliver desired outcomes. Achieves success with focus on accomplishing **tasks**.

Primary  
LOB Affinity

Latitude 9000, 7000

Latitude 7000, 5000

Precision Fixed & Mobile Workstation

OptiPlex | Latitude 5000, 3000 |  
Precision Mobile 3000 Workstation

DELL Technologies



# The Builder

Driven to build and grow the business.

Creates and executes strategic **vision**.

Moves companies forward developing **relationships** with **external** stakeholders and partners.

## CHARACTERISTICS



10% Workforce



76% Use Multiple Workspaces



20% More Mobile



2 days Work From Office / Week

## BUILDER NEEDS CHART\*

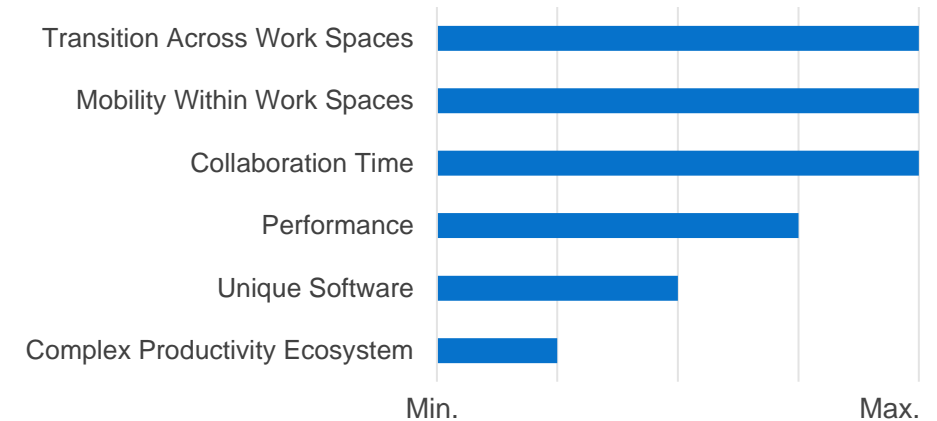

\*Relative To Others

DELL Technologies

### MOTIVATION

- Are constantly connected via several devices across multiple workspaces
- Thrive using simplified and effective communication
- Require a high degree of aura across lifestyle and devices

### ROLE AFFINITY

- C-Suite Executives
- P&L Owners
- External Sales
- Account Management
- Public Relations Representatives
- Business Consultants
- Lawyers
- Real Estate Agents

### PRIORITY PAIN POINTS

- Challenges setting up devices across ecosystem
- Difficulty with transition across workspaces and devices
- Need to collaborate and be connected regardless of location
- Desire for a clean and efficient workspace
- Regularly managing connectivity and power



# Hybrid Work Solutions For Builder

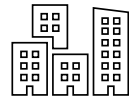

## Office



UltraSharp 40 Curved WUHD Monitor U4021QW



UltraSharp Webcam WB7022



Thunderbolt 4 Dock WD22TB4



Premier Wireless ANC Headset WL7022



Premier Multi-Device Wireless Keyboard & Mouse KM7321W



## Roam



Latitude 9430

ExpressConnect  
ExpressResponse  
ExpressSign-In  
Contextual Privacy

Dell Optimizer &  
Dell Peripheral Manager Integration

Dell Software Experiences



14 Portable Monitor C1422H



Premier Rechargeable Active Pen PN7522W



USB-C Mobile Adapter DA310



Premier Wireless ANC Headset WL7022



Premier Rechargeable Wireless Mouse MS7421W



## Home



UltraSharp 4K 32 Video Conferencing Monitor U3223QZ



Dual Charge Dock HD22Q



Premier Multi-Device Wireless Keyboard & Mouse KM7321W

# The Connector



Driven to **connect** teams and ensure **collaboration**.

Manages plans and data to advance projects.

Enables **progress** by balancing between collaboration and distractions.

## CHARACTERISTICS



**19%** Workforce



**68%** Use Multiple Workspaces



High Collaboration Application Usage



**2.3 days** Work From Office / Week

## CONNECTOR NEEDS CHART\*

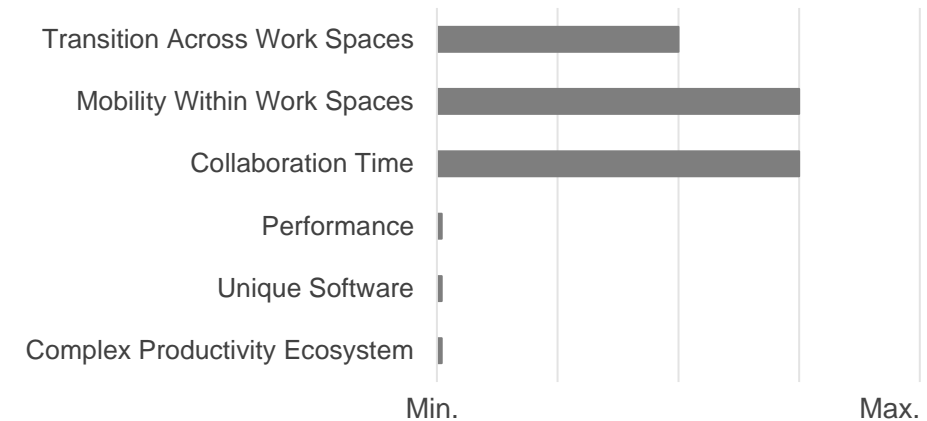

\*Relative To Others

**DELL**Technologies

# Hybrid Work Solutions For Connector

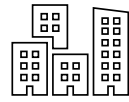

## Office



34 Curved Video Conferencing Monitor - C3422WE



Thunderbolt 4 Dock WD22TB4



Premier Wireless ANC Headset WL7022



Premier Multi-Device Wireless Keyboard & Mouse KM7321W



## Roam



Latitude 7430  
Latitude 7330 (for Roam)



14 Portable Monitor C1422H



Speakerphone with Multiport Adapter MH3021P



Premier Wireless ANC Headset WL7022



Premier Rechargeable Wireless Mouse MS7421W



Notebook Power Bank Plus (USB-C, 65Whr) - PW7018LC



## Home



34 Curved Video Conferencing Monitor - C3422WE



Dual Charge Dock HD22Q



Premier Wireless ANC Headset WL7022



Premier Multi-Device Wireless Keyboard & Mouse KM7321W

Dell Software Experiences

ExpressConnect  
ExpressResponse  
ExpressSign-In  
Contextual Privacy

Dell Optimizer &  
Dell Peripheral Manager Integration

**DELL**Technologies



# The Specialist

Driven to specialize in unique, **creative**, and **complex** fields.

Generates focused work and performs detailed **analysis**.

Solves difficult challenges in a logical and detail-oriented manner.

## CHARACTERISTICS



15% Workforce



43% Work From Home



80% More Performance Needs  
x2 Performance Applications



1.7 days Work From Office / Week



Large Mix of Verticals

## SPECIALIST NEEDS CHART\*

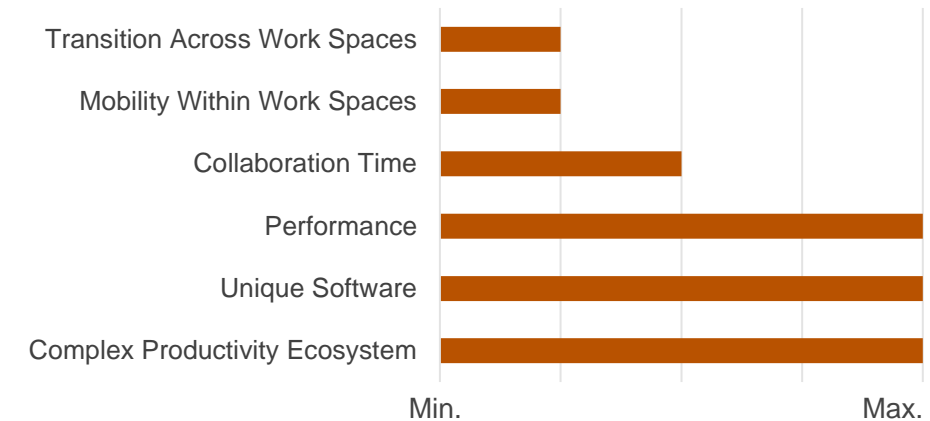

\*Relative To Others

DELL Technologies

### MOTIVATION

- Produce expert level deliverables
- Satisfaction and pride in seeing their project drive outcomes
- Excited by challenge to solve complex problems and deliver unique solutions

### ROLE AFFINITY

- Researchers
- Data Scientist
- Engineer
- Analysts
- Architects
- Professional Artists
- Designers
- Programmers
- Database Developers

### PRIORITY PAIN POINTS

- Disruption in speed and power
- Interruption in deep focus
- Lack of screen real estate and ability to customize setup
- Hindered by lack of and changes to specific peripherals
- Inability to access optimal software

# Hybrid Work Solutions For Specialist



Precision 3660 Tower  
(for Office)



Precision 5470  
(for Roam & Home)

ExpressConnect  
ExpressResponse  
ExpressSign-In  
Contextual Privacy

ISV Certifications  
Dell Optimizer for Precision  
Easy Arrange

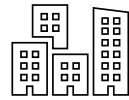

Office



2x UltraSharp 27 4K USB-C  
Hub Monitors U2723QE



UltraSharp Webcam  
WB7022



Premier Wireless ANC  
Headset WL7022



Premier Multi-Device Wireless  
Keyboard & Mouse KM7321W



Roam



14 Portable Monitor  
C1422H



Speakerphone with Multiport  
Adapter MH3021P



Premier Wireless ANC  
Headset WL7022



Premier Rechargeable  
Wireless Mouse MS7421W



Home



2x UltraSharp 27 4K USB-C  
Hub Monitors U2723QE



Thunderbolt 4 Dock  
WD22TB4



Speakerphone  
SP3022



Premier Wireless ANC  
Headset WL7022



Premier Multi-Device Wireless  
Keyboard & Mouse KM7321W

Dell Software Experiences

# NVIDIA RTX

Powering Innovation Across Industries

## M&E



Courtesy of Silver Spoon

## MFG & Product Design



Image courtesy of Pagani and MHP—a Porsche Company.

## AECO

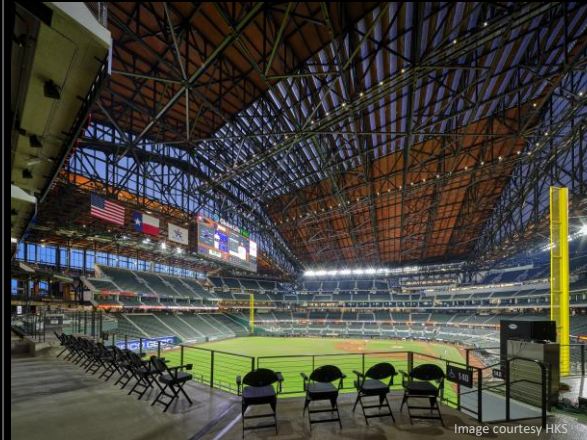
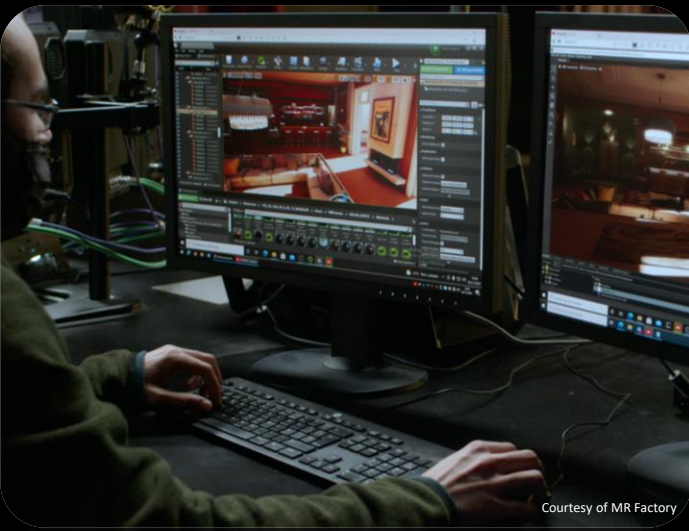

Image courtesy HKS

## SCI VIZ



Proprio Vision



Courtesy of MR Factory

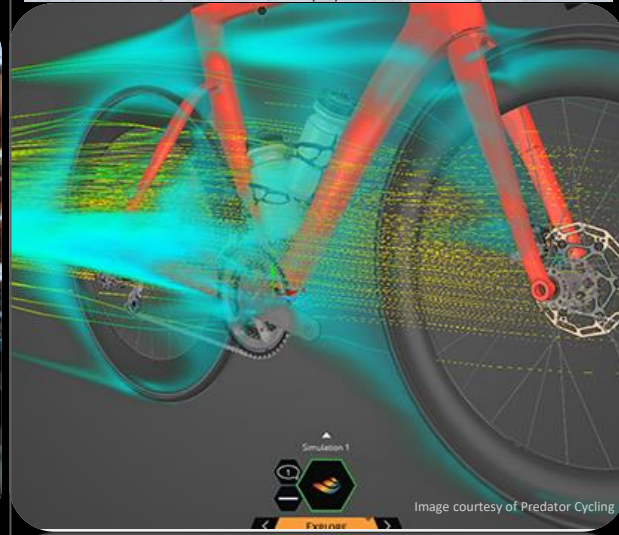

Image courtesy of Predator Cycling



Image Courtesy of KPF



Image courtesy NASA Solar Dynamics Observatory

# NVIDIA RTX in Every Form Factor

Solutions to Do Your Best Work Anywhere

## Desktop



RTX 6000 Ada Generation (48GB)  
RTX A6000 (48GB)  
RTX A5500 (24GB)  
RTX A5000 (24GB)  
RTX A4500 (20GB)  
RTX A4000 (16GB)  
RTX A2000 12GB

## Laptop



RTX A5500 (16GB)  
RTX A4500 (16GB)  
RTX A3000 12GB  
RTX A2000 8GB  
RTX A1000 (4GB)  
RTX A500 (4GB)

## Data Center



NVIDIA A40 (48GB)  
NVIDIA A16 (4x16GB)



# The Producer

Driven to produce results and strives for **efficiency**.

Focuses on **productivity** to deliver desired outcomes.

Achieves success with focus on accomplishing **tasks**.

## CHARACTERISTICS



**>50%** Workforce



**52%** Work From Home & Office



**22%** More Task Focused



**x2** More Desktop Usage



**2.8 days** Work From Office / Week



Largest Mix of Verticals

## PRODUCER NEEDS CHART\*

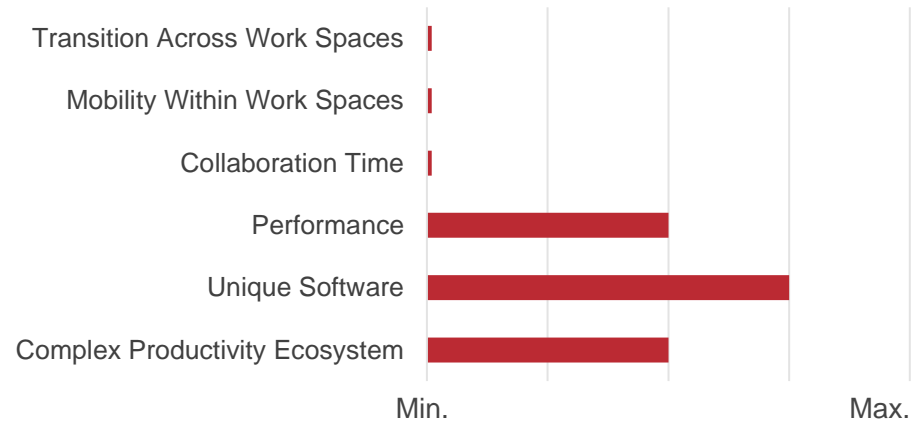

\*Relative To Others

### MOTIVATION

- Focused efficiency
- Goal and customer centric
- Time to completion

### ROLE AFFINITY

- Accountants
- Procurement
- IT Administrators
- Manufacturing Floor
- Finance Admins
- Human Resources
- Front Office Reps
- Admin Assistants
- Call Center

### PRIORITY PAIN POINTS

- Extreme challenges with slow and unreliable devices
- Delaying focused work till optimal ergonomic setting
- Background noise and avoiding distractions
- Status meetings get in the way of "real" work



# Hybrid Work Solutions For Producer(Fixed)



OptiPlex 7400 All-in-One

  
**Office  
 Service  
 Desk/Kiosk**



All-in-One Height Adjustable Stand



Pro Wireless Headset  
 WL5022



Premier Multi-Device Wireless  
 Keyboard & Mouse KM7321W

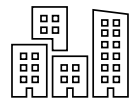

**Office  
 Shop Floor**

Dell Software Experiences



27 USB-C HUB Monitor  
 P2723DE



Micro All-in-One Stand  
 MFS22



Premier Multi-Device Wireless  
 Keyboard & Mouse KM7321W



OptiPlex 7000 Micro  
 (for Fixed Shop Floor & Home)



**Home**



2x 27 USB-C HUB Monitor  
 P2723DE



UltraSharp Webcam  
 WB7022



Speakerphone  
 SP3022



Pro Wireless Headset  
 WL5022



Pro Wireless Keyboard  
 and Mouse KM5221W



Dual Monitor  
 Arm MDA20

ExpressConnect  
 ExpressResponse  
 Dell Optimizer & Dell Peripheral Manager  
 Integration

# Hybrid Work Solutions For Producer (Mobile)



## Office



2x 27 USB-C HUB Monitor  
P2723DE



Thunderbolt 4 Dock  
WD22TB4



Pro Wireless Headset  
WL5022



Pro Wireless Keyboard  
and Mouse KM5221W



## Home



2x 27 USB-C HUB Monitor  
P2723DE



Dual Charge Dock  
HD22Q



Speakerphone  
SP3022



Pro Wireless Headset  
WL5022



Pro Wireless Keyboard  
and Mouse KM5221W



Latitude 5430

ExpressConnect  
ExpressResponse  
ExpressSign-In  
Contextual Privacy

Dell Optimizer  
Easy Arrange

Dell Software Experiences

# Enhance Your Employee Experience



Define **your success**, measure experience and reprioritize strategy to maximize organizational impact

Leverage **your voice** to effectively drive change and new tech adoption

[DellTechnologies.com/Persona](https://DellTechnologies.com/Persona)



# Dell Digital Employee Experience Services



• ADVANCING  
**SUSTAINABILITY**

# RECYCLED AND RENEWABLE MATERIALS

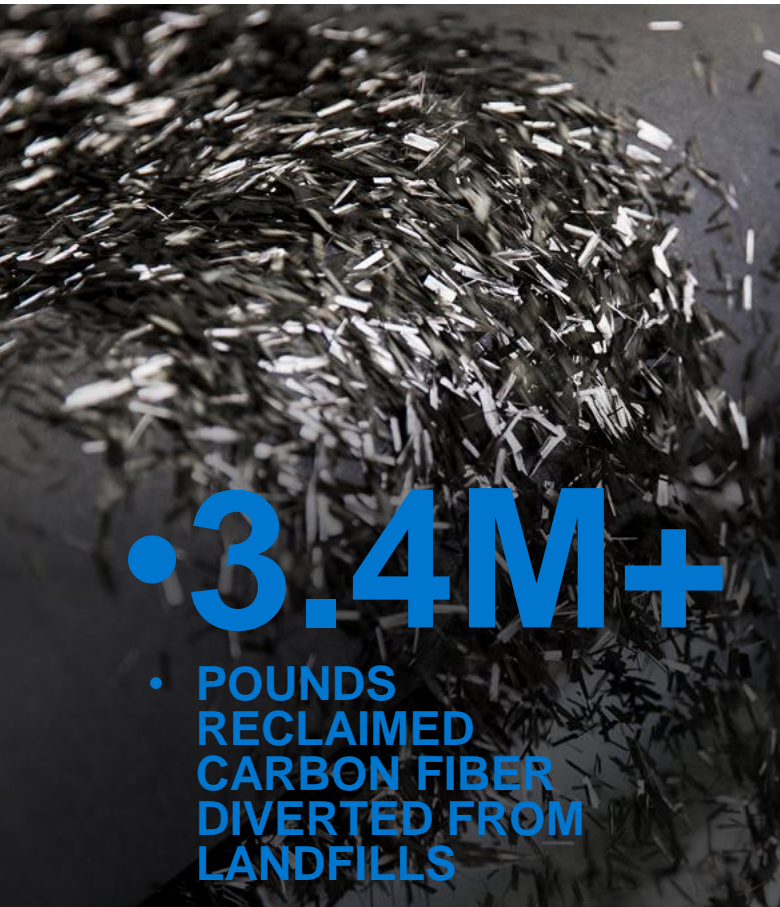

• **3.4M+**

- POUNDS RECLAIMED CARBON FIBER DIVERTED FROM LANDFILLS



• **125+**

- PRODUCTS USING RECYCLED PLASTICS FROM USED ELECTRONICS

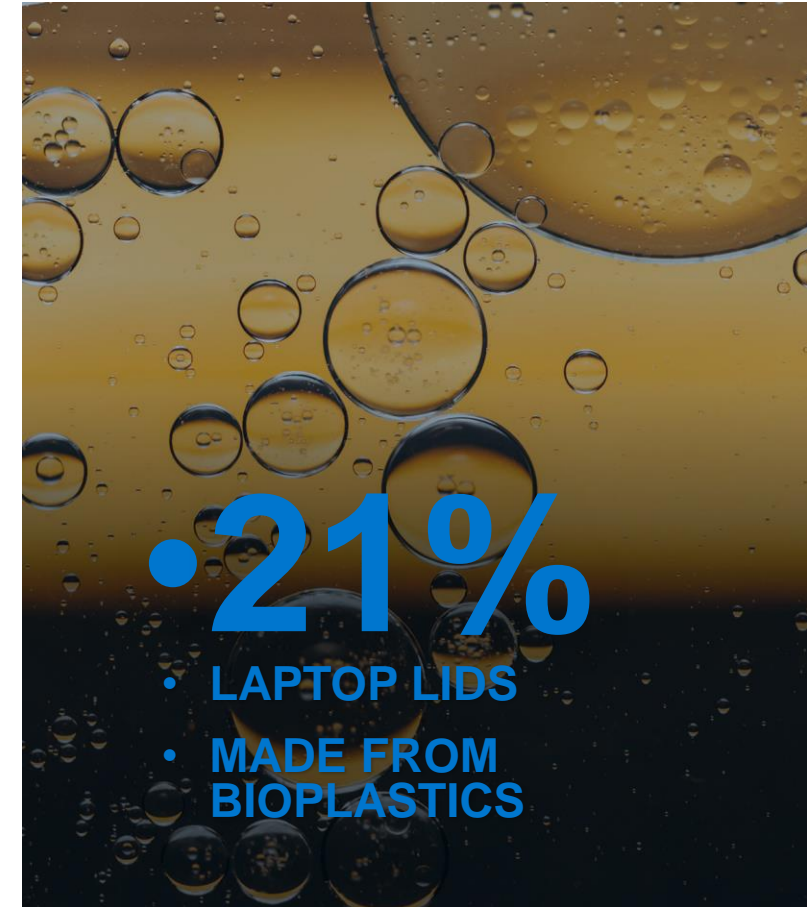

• **21%**

- LAPTOP LIDS
- MADE FROM BIOPLASTICS

# Sustainability on Dell Latitude

- 🌿 Biobased material rubber feet (9330,7000, 5000)
- 🌿 Recycled plastic fan housing & battery frame (9330, 5000) / battery frame only (7000)
- 🌿 Keycaps from recycled materials (9330)
- 🌿 Packaging made from 100% recycled / renewable materials
- 🌿 Bulk packaging options to reduce waste



## Ecolabels

90+

EPEAT registered products

100%

EPEAT Gold in 2021 products

38

TCO 8 certified configurations

8.0

ENERGY STAR® throughout the portfolio

# New Sustainable Packaging meets 2023 Goals

- 100% recyclable materials, 92% less plastic (no plastic bags/wraps, uses 100% recycled non-woven bag):

## Latitudes CY21

Current Notebook Brown Box Packaging

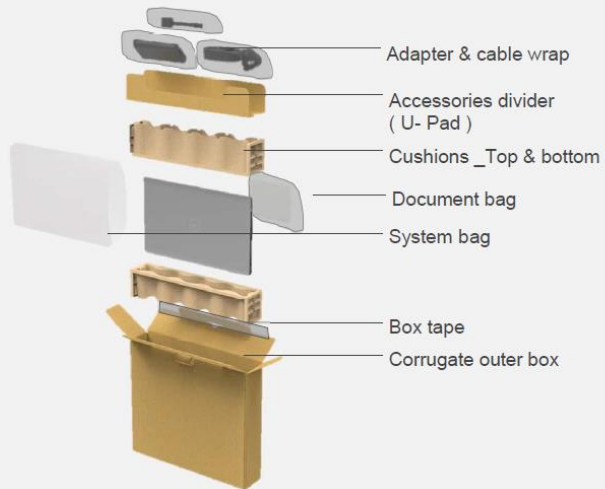

## Latitudes 3, 5 & 7: CY22

Enhanced Notebook Packaging



## Latitudes 9000: CY22

New 9000 Series Premium Packaging



## Latitudes CY22

Notebook Multipack – 5-Pack

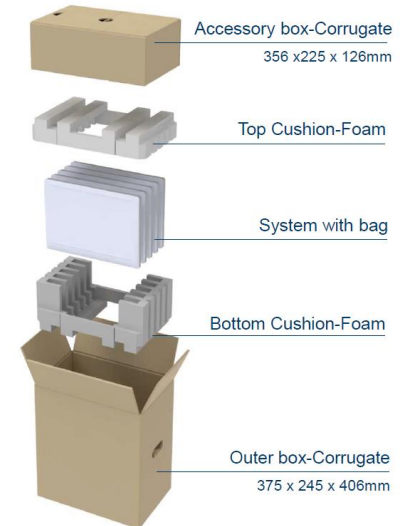

# Concept Luna

Reducing, reusing and recreating to push the boundaries of sustainable PC design.

- Created to test what could be possible, not to be manufactured and sold – the design ideas in Concept Luna explore making components easily accessible, replaceable and reusable, reducing resource use and keeping even more circular materials in the economy

## Initial results from Concept Luna

- 50% reduction in carbon footprint
- 10x fewer screws for easy access to internal components
- Easily removable display and keyboard for direct access to all components
- Keystone innovation locks components without adhesives
- 75% reduction in the size of the motherboard
- Aluminum processed using hydro-power





**DELL**Technologies